

Data Sheet



Article number: 12621000100000

Description: Industrial tool 621 000 100.000
For M10

Measures

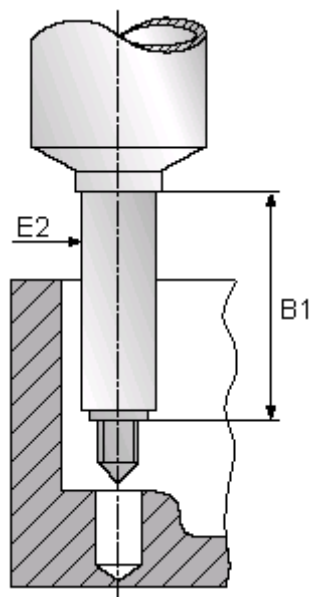

B1	= 60
E2	= 15
For thread	= M10